

BOUNDS FOR THE MINIMUM ORIENTED DIAMETER

SASCHA KURZ AND MARTIN LÄTSCH

ABSTRACT. We consider the problem of finding an orientation with minimum diameter of a connected bridgeless graph. Fomin et. al. [7] discovered a relation between the minimum oriented diameter and the size of a minimal dominating set. We improve their upper bound.

1. INTRODUCTION

An orientation of an undirected graph G is a directed graph whose arcs correspond to assignments of directions to the edges of G . An Orientation H of G is strongly connected if every two vertices in H are mutually reachable in H . An edge e in a undirected connected graph G is called a bridge if $G - e$ is not connected. A connected graph G is bridgeless if $G - e$ is connected for every edge e , i. e. there is no bridge in G .

The conditions when an undirected graph G admits a strongly connected orientation are determined by Robbins in 1939 [25]. The necessary and sufficient conditions are that G is connected and bridgeless. Chung et. al provided a linear-time algorithm for testing whether a graph has a strong orientation and finding one if it does [1].

Definition 1.1. Let \vec{G} be a strongly connected directed graph. By $\text{diam}(\vec{G})$ we denote the diameter of \vec{G} . For a simple graph connected G without bridges we define

$$\vec{\text{diam}}_{\min}(G) := \min \left\{ \text{diam}(\vec{G}) : \vec{G} \text{ is an orientation of } G \right\},$$

which we call the minimum oriented diameter of a simple graph G . By $\gamma(G)$ we denote the smallest cardinality of a vertex cover of G .

We are interested in the examples G which have a large minimum oriented diameter $\vec{\text{diam}}_{\min}(G)$ in dependence of its domination number $\gamma(G)$. Therefore we set

$$\Xi(\gamma) := \max \left\{ \vec{\text{diam}}_{\min}(G) : \gamma(G) \leq \gamma \text{ for } G \text{ being a bridgeless connected graph} \right\}.$$

The aim of this note is to prove a better upper bound on $\Xi(\gamma)$. The previously best known result [7] was:

Theorem 1.2.

$$\Xi(\gamma) \leq 5\gamma - 1.$$

Our main results are

Theorem 1.3.

$$\Xi(\gamma) \leq 4\gamma$$

and

2000 *Mathematics Subject Classification.* 05C12;05C20,05C69.

Key words and phrases. diameter, orientation, domination.

Conjecture 1.4.

$$\Xi(\gamma) = \left\lceil \frac{7\gamma(G) + 1}{2} \right\rceil.$$

Clearly we have $\Xi(\gamma)$ is weak monotone increasing. At first we observe that we have $\Xi(\gamma) \geq \left\lceil \frac{7\gamma(G)+1}{2} \right\rceil$. Therefore we consider the following set of examples, where we have depicted the vertices of a possible minimal vertex cover by a filled black circle:

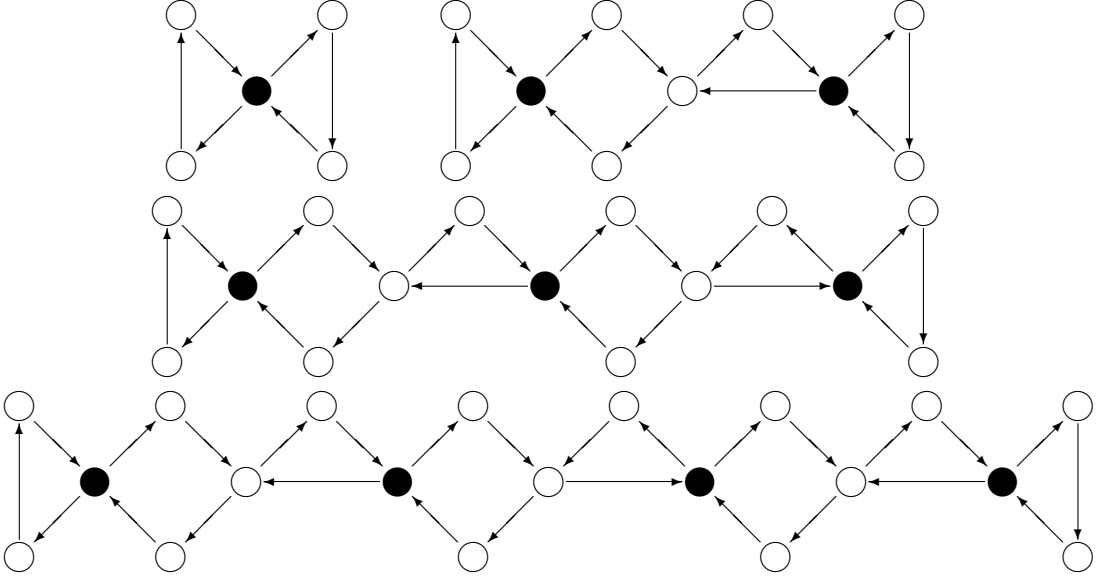

FIGURE 1. Examples with large minimum oriented diameter in dependence of the domination number $\gamma(G)$.

If we formalize this construction of graphs G , which is depicted for $\gamma(G) = \gamma = 1, 2, 3, 4$ we obtain examples which attain the proposed upper bound $\left\lceil \frac{7\gamma(G)+1}{2} \right\rceil$ for all $\gamma \in \mathbb{N}$. In the following we always depict vertices in a given vertex cover by a filled circle.

1.1. Related results. Instead of an upper bound of $\overrightarrow{\text{diam}}_{\min}(G)$ in dependence of $\gamma(G)$ one is also interested in an upper bound in dependence of the diameter $\text{diam}(G)$. Here the best known result is given by [2]:

Theorem 1.5. (Chvátal and Thomassen, 1978) Let $f(d)$ denote the best upper bound on $\overrightarrow{\text{diam}}_{\min}(G)$ where $d = \text{diam}(G)$ and G is connected and bridgeless.

If G is a connected bridgeless graph then we have

$$\frac{1}{2} \text{diam}(G)^2 + \text{diam}(G) \leq f(d) \leq 2 \cdot \text{diam}(G) \cdot (\text{diam}(G) + 1).$$

In [2] it was also shown that we have $f(2) = 6$. Examples achieving this upper bound are given by the Petersen graph and by the graph obtained from K_4 by subdividing the three edges incident to one vertex. Recently in [21] $9 \leq f(3) \leq 11$ was shown.

The oriented diameter is trivially at least the diameter. Graphs where equality holds are said to be *tight*. In [15] some Cartesian products of graphs are shown to be tight. For $n \geq 4$ the n -cubes are tight [22]. The discrete tori $C_n \times C_m$ which are tight are completely determined in [20].

The origin of this problem goes back to 1938, where Robbins [25] proves that a graph G has a strongly connected orientation if and only if G has no cut-edge. As an application one might think of making streets of a city one-way or building a communication network with links that are reliable only in one direction.

There is a huge literature on the minimum oriented diameter for special graph classes, see i.e. [11, 12, 13, 14, 16, 17, 18, 19, 23].

From the algorithmic point of view the following result is known [2]:

Theorem 1.6. *The problem whether $\overrightarrow{\text{diam}}_{\min}(G) \leq 2$ is \mathcal{NP} -hard for a given graph G .*

We remark that the proof is based on a transformation to the problem whether a hypergraph of rank 3 is two-colorable.

2. PRELIMINARIES

A vertex set $D \subseteq V(G)$ of a graph G is said to be a dominating set of G if for every vertex $u \in V(G) \setminus D$ there is a vertex $v \in D$ such that $\{u, v\} \in E(G)$. The minimum cardinality of a dominating set of a graph G is denoted by $\gamma(G)$. If P is a path we denote by $|P|$ its length which equals the number of its edges. An elementary cycle C of a graph $G = (V, E)$ is a list $[v_0, \dots, v_k]$ of vertices in V , where $v_0 = v_k$, $|\{v_0, \dots, v_k - 1\}| = k$ and $\{v_i, v_{i+1}\} \in E$ for $0 \leq i < k$. Similarly $|C|$ denotes the length of C which equals the number of its edges and vertices. For other not explicitly mention graph-theoretic terminology we refer the reader to [6] for the basic definitions.

Our strategy to prove bounds on $\Xi(\gamma)$ is to apply some transformations on bridgeless connected graphs attaining $\Xi(\gamma)$ to obtain some structural results. Instead of considering graphs G from now on we will always consider pairs (G, D) , where D is a dominating set of G .

Definition 2.1. For a graph G and a dominating set D of G we call $\{u, v\} \subseteq V(G) \setminus D$ an isolated triangle if there exists an $w \in D$ such that all neighbors of u and v are contained in $\{u, v, w\}$ and $\{u, v\} \in E(G)$. We say that the isolated triangle is associated with $w \in D$.

Definition 2.2. A pair (G, D) is in first standard form if

- (1) $G = (V, E)$ is a connected simple graph without a bridge,
- (2) D is a dominating set of G with $|D| = \gamma(G)$,
- (3) for $u, v \in D$ we have $\{u, v\} \notin E$,
- (4) for each $u \in V \setminus D$ there exists exactly one $v \in D$ with $\{u, v\} \in E$, and
- (5) G is edge-minimal, meaning one can not delete an edge in G without creating a bridge, destroying the connectivity or destroying the property of D being a dominating set,
- (6) for $|D| = \gamma(G) \geq 2$ every vertex in D is associated with exactly one isolated triangle and for $|D| = \gamma(G) = 1$ the vertex in D is associated with exactly two isolated triangles.

Lemma 2.3.

$$\Xi(\gamma) = \max \left\{ \overrightarrow{\text{diam}}_{\min}(G) : |D| \leq \gamma, (G, D) \text{ is in first standard form} \right\}.$$

PROOF. For a given $\gamma \in \mathbb{N}$ we start with a bridgeless connected graph G' attaining $\Xi(\gamma) = \overrightarrow{\text{diam}}_{\min}(G')$ and minimum domination number $\gamma(G')$. Let D' be an arbitrary dominating set of G' fulfilling $|D'| = \gamma(G')$. Our aim is to apply some graph transformations onto (G', D') to obtain a pair (G, D) in first standard form fulfilling $\overrightarrow{\text{diam}}_{\min}(G) \geq \overrightarrow{\text{diam}}_{\min}(G')$ and $|D| \leq |D'|$.

At the start conditions (1) and (2) are fulfilled. If there is an edge e between two nodes of D then we recursively apply the following graph transformation until there exists no such edge:

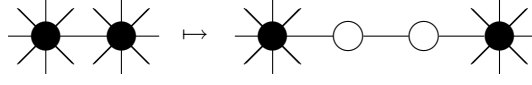

If there exists a node $v \in V \setminus D$ with at least $r \geq 2$ neighbors d_1, \dots, d_r in D then we replace the edge (v, d_i) $i = 2, \dots, r$ with a path of length 2. We iterate this until case (4) is fulfilled. In Figure 2 we have depicted the graph transformation for $r = 2, 3$.

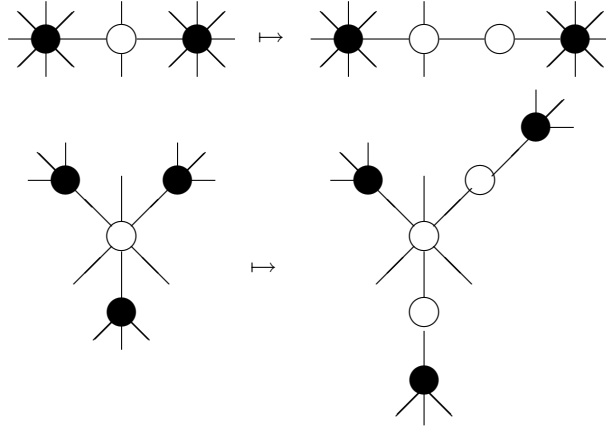

FIGURE 2. Graph transformation to fulfill condition (4) of Definition 2.2

So after a finite number of transformation we have constructed a pair (G, D) which fulfills conditions (1), (3), (4) of the first standard form where D is a dominating set of G and (G, D) also fulfills

$$\gamma(G) \leq |D| \leq |D'| = \gamma(G')$$

and

$$\infty > \overrightarrow{\text{diam}}_{\min}(G) \geq \overrightarrow{\text{diam}}_{\min}(G').$$

To additionally fulfill condition (5) of the first standard form we only need to delete the controversial edges. If $\gamma(G) < |D| \leq \gamma(G')$ we would have a contradiction to the minimality of $\gamma(G')$. Since adding isolated triangles does not contradict with the other properties and also does not decrease the minimum oriented property we can assume that every vertex of D is associated with enough isolated triangles. For two vertices x and y in two different isolated triangles being associated with the same vertex $w \in D$ we have $d(x, y) \leq 4$ in every strongly connected orientation. Thus we can delete some isolated triangles to achieve the stated number of isolated triangles for every vertex in the dominating set D . Finally we have a pair (G, D) in first standard form. \square

So in order to prove bounds on $\Xi(\gamma)$ we can restrict ourselves on pairs (G, D) in first standard form. Due to Theorem 1.2 we can assume $\gamma(G) = |D| \geq 2$ both for the proof of Theorem 1.3 and also for Conjecture 1.4.

Corollary 2.4. *If (G, D) is a pair in first standard form then we have*

- (i) *for all $u, v \in D$ the distance fulfills $d(u, v) \geq 3$ and*
- (ii) *for all $u \in V(G) \setminus D$ there exists exactly one $f(u) \in D$ with $\{u, f(u)\} \in E(G)$.*

Let G be a bridgeless connected undirected graph, D be a dominating set of G and H be a strongly connected orientation of G . By $\text{diam}_i(H, D)$ we denote

$$\max \left\{ d_H(u, v) : \left| \{u, v\} \cap (V(H) \setminus D) \right| = i \right\}.$$

Clearly we have $\text{diam}(H) = \max \left\{ \text{diam}_0(H, D), \text{diam}_1(H, D), \text{diam}_2(H, D) \right\}$. Now we refine a lemma from [7]:

Lemma 2.5. *Let G' and G be bridgeless connected graphs such that G is a subgraph of G' and D is a dominating set of both G' and G . Then for every strongly connected orientation H of G there is an orientation H' of G' such that*

$$\text{diam}(H') \leq \max \left\{ \text{diam}_0(H, D) + 4, \text{diam}_1(H, D) + 2, \text{diam}_2(H, D) \right\}.$$

PROOF. (We rephrase most of the proof from [7].) We adopt the direction of the edges from H to H' . For the remaining edges we consider connected components Q of $G' \setminus V(G)$ and direct some edges having ends in Q as follows.

If Q consists of one vertex x then x is adjacent to at least one vertex u in D and to another vertex $v \neq u$ (the graph G is bridgeless and D is a dominating set). If also v is an element of D then we direct one edge from x and the second edge towards x . Otherwise v is in $V \setminus D$. In this case we direct the edges $[x, u]$ and $[v, x]$ in the same direction as the edge $[f(v), v]$. If there are more edges incident with x (in both cases) we direct them arbitrarily. Then, we have assured the existence of vertices $u', v' \in D$ such that $d_{H'}(x, v') \leq 2$ and $d_{H'}(u', x) \leq 2$.

Suppose that there are at least two vertices in the connected component Q . Choose a spanning tree T in this component rooted in a vertex v . We orient edges of this tree as follows: If a vertex x of the tree has odd distance from v , then we orient all the tree edges adjacent to x from x outwards. Also, for every such vertex x we orient the edges between x and $V(G)$ towards x if the distance from v on the tree is even, and towards $V(G)$ otherwise, see Figure 1 in [7]. The rest of the edges in the connected component Q are oriented arbitrarily.

In such an orientation H' , for every vertex $x \in Q$ there are vertices $u, v \in D$ such that $d_{H'}(x, v) \leq 2$ and $d_{H'}(u, x) \leq 2$. Therefore, for every $x, y \in V(G')$ the distance between x and y in H' is at most

$$\max \left\{ \text{diam}_0(H, D) + 4, \text{diam}_1(H, D) + 2, \text{diam}_2(H, D) \right\}.$$

□

Due to the isolated triangles being associated with the vertices of the dominating set D , for every pair (G, D) in first standard form, there exists an orientation H of G such that

$$\overrightarrow{\text{diam}}_{\min}(G) = \text{diam}(H) = \max \left\{ \text{diam}_0(H, D) + 4, \text{diam}_1(H, D) + 2, \text{diam}_2(H, D) \right\}. \quad (1)$$

If we say that H is an optimal or an minimal orientation of (G, D) we mean an orientation that fulfills Equation 1.

In [7] the authors have described a nice construction to obtain such a subgraph G for a given bridgeless connected graph G' fulfilling $|V(G)| \leq 5 \cdot \gamma(G') - 4$:

For $\gamma(G') = 1$ we may simply choose the single vertex in D as our subgraph D . Now we assume $|D| = \gamma(G') \geq 2$. Iteratively, we construct a tree T_k for $k = 1, \dots, |D|$. The tree T_1 is composed by one vertex x_1 in D . To construct T_{k+1} from T_k we find a vertex x_{k+1} in $D \setminus V(T_k)$ with minimum distance to T_k . The tree T_{k+1} is the union of T_k with a shortest path from x_{k+1} to T_k . Since D is a dominating set this path has length at most 3. We say that the edges of this path are *associated* with x_{k+1} . At the last step we obtain a dominating tree T with $D \subseteq T$ and with $|V(T)| \leq 2(|D| - 1) + |D|$.

In order to transform T in a bridgeless connected graph we construct a sequence of subgraphs G_k for $k = 1, \dots, |D|$. We say that $x_j \in D$ is *fixed* in G_k if no edge associated with x_j is a bridge in G_k . Notice that x_1 is fixed in T because it does not have any associated edge.

We set $G_1 = T$. Assume we have constructed the subgraph G_k . If x_{k+1} is already fixed in G_k we set $G_{k+1} = G_k$. If x_{k+1} is not fixed in G_k we add a subgraph M to G_k to obtain G_{k+1} .

Let P_k be the path added to T_k to obtain T_{k+1} . We only consider the case where P_k has length three. The other cases can be done similarly. Let us assume that P_k is given by $P_k = (x_{k+1}, u, v, x_j)$ with $u, v \notin D$, and $x_j \in D$, $j \leq k$. Moreover let us denote the edges of P_k by e, e' and e'' . If we remove all edges e, e', e'' of P_k from T we obtain four subtrees T^1, T^2, T^3 and T^4 containing x_{k+1}, u, v and x_j , respectively.

Among all shortest path in $G \setminus e$ connecting T^1 with $T^2 \cup T^3 \cup T^4$ we select P as one whose last vertex belongs to T^i with i maximum. Among all shortest path in $G \setminus e''$ connecting T^4 with $T^1 \cup T^2 \cup T^3$ we select Q as one whose first vertex belongs to T^i with i minimum. Let R be any shortest path in $G \setminus e'$ connecting $T^3 \cup T^4$ with $T^1 \cup T^2$.

Since G' is a bridgeless connected graph the paths P, Q, R exist. Since $D \subseteq V(T)$ and the set D is a dominating set, the length of paths P, Q and R is at most 3. Moreover, if the length of P is three its end vertices belong to D . The same holds for the paths Q and R .

The definition of M is given according to the following cases. If the last vertex of P belongs to T^4 we define $M = P$. If the last vertex of P belongs to T^3 or it belongs to T^2 and the first vertex of Q belongs to T^2 we define $M = P \cup Q$. If none of the previous cases hold the first vertex of R belongs to T^2 and the last one belongs to T^3 . We define $M = P \cup Q \cup R$.

For the analysis that $|V(G_{|D|})| \leq 5 \cdot \gamma(G') - 4$ we refer to [7].

Since a shortest path does contain every vertex at most once, we can combine the above described construction of a subgraph with Lemma 2.5 to obtain the bound $\Xi(\gamma) \leq 5\gamma - 1$.

Lemma 2.6.

$$\Xi(1) = 4 \text{ and } \Xi(2) = 8.$$

PROOF. At first we observe that the examples from Figure 1 give $\Xi(1) \geq 4$ and $\Xi(2) \geq 8$. For the other direction let (G, D) be a pair in first standard form attaining $\overrightarrow{\text{diam}}_{\min}(G) = \Xi(\gamma(G))$. For $\gamma = \gamma(G) = 1$ we have $|D| = 1$, choose the single vertex of D as a subgraph and apply Lemma 2.5. Going through the cases of the above described subgraph construction for $\gamma = \gamma(G) = 2$ we obtain up to symmetry the two possibilities given in Figure 3. By H be denote the depicted corresponding orientation of the edges. Since in both cases we have $\text{diam}_0(H, D) \leq 4$ and $\text{diam}_1(H, D), \text{diam}_2(H, D) \leq 5$ we can apply Lemma 2.5 to obtain the stated result. \square

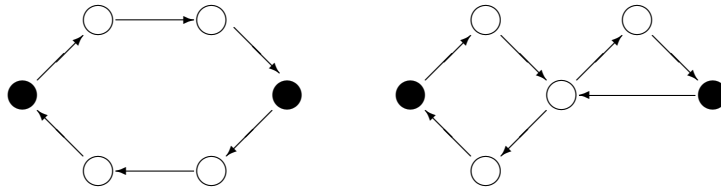

FIGURE 3. The two possible subgraphs for $\gamma(G) = 2$.

With Lemma 2.5 in mind we would like to restrict our investigations on bridgeless connected subgraphs containing the dominating set.

Definition 2.7. For a pair (G', D) in first standard form we call G a minimal subgraph of (G', D) , if

- (1) G is a subgraph of G' containing the vertex set D ,
- (2) G is bridgeless connected,
- (3) for every vertex $v \in V(G) \setminus D$ we have $\{v, f(v)\} \in E(G)$, where $f : V(G') \setminus D \rightarrow D$ is the function from the first standard form of (G', D) , and
- (4) G is vertex and edge-minimal with respect to properties (1), (2), and (3).

Corollary 2.8. *If G is a minimal subgraph of (G', D) in first standard form, we have*

- (1) $|V(G)| \leq 5 \cdot |D| - 4$ and
- (2) *there exists no chord $\{u, v\} \in E(G)$, where $\{u, v\} \cap D = \emptyset$.*

Definition 2.9. Let G be a minimal subgraph of (G', D) in first standard form. We construct a graph \tilde{G} from G by adding isolated triangles at vertices of D such that (\tilde{G}, D) is in first standard form. We call \tilde{G} a minimal completion and we say that H is a minimal or an optimal orientation of G , if H is strongly connected and we have

$$\overrightarrow{\text{diam}}_{\min}(\tilde{G}) \geq \max \left\{ \text{diam}_0(H, D) + 4, \text{diam}_1(H, D) + 2, \text{diam}_2(H, D) \right\}.$$

By considering the isolated triangles being associated to the vertices of the dominating set D we can easily check, that every minimal subgraph G of a pair (G', D) in first standard form admits a minimal orientation H and that we have $\overrightarrow{\text{diam}}_{\min}(G') \leq \overrightarrow{\text{diam}}_{\min}(\tilde{G})$. If G does only fulfill conditions (1)-(3) of Definition 2.7 then we may consider a minimal subgraph G'' of (G', D) , which contains G as a subgraph. With this we can call an orientation H of G minimal or optimal if it is minimal or optimal for G'' .

Definition 2.10. We call a pair (G', D) in first standard form critical, if $\Xi(\gamma(G')) = \overrightarrow{\text{diam}}_{\min}(G')$.

Definition 2.11. We call a minimal subgraph G of (G', D) in first standard form critical if for a minimal orientation H of G we have

$$\Xi(\gamma(G')) = \max \left\{ \text{diam}_0(H, D) + 4, \text{diam}_1(H, D) + 2, \text{diam}_2(H, D) \right\}.$$

Together with Lemma 2.5 we obtain:

Lemma 2.12.

$$\begin{aligned} \Xi(\gamma) = \max \left\{ \min \left\{ \max \{ \text{diam}_0(H, D) + 4, \text{diam}_1(H, D) + 2, \text{diam}_2(H, D) \} : \right. \right. \\ \left. \left. \begin{array}{l} H \text{ is strongly connected orientation of } G \\ \text{subgraph of } (G', D) \text{ in first standard form with } |D| = \gamma \end{array} \right\} \right\}. \end{aligned}$$

Sometimes it is useful to know some basic facts about strongly connected orientations of graphs.

Lemma 2.13. (1) *If H is a strongly connected orientation of an undirected graph G and C is a directed cycle without repeated edges in H , then inverting of the edges of C yields another strongly connected orientation of G .*

(2) *If H is a strongly connected orientation of an undirected graph G and P_1 and P_2 are two edge-disjoint directed paths from x to y , then inverting P_2 yields another strongly connected orientation of G .*

(3) *If H is a strongly connected orientation of an undirected graph G then inverting all edges yields another strongly connected orientation with equal diameter.*

3. REDUCTIONS

In this section we will propose some reductions for critical minimal subgraphs G of pairs (G', D) in first standard form, in order to provide some tools for an inductive proof of a better upper bound on $\Xi(\gamma)$.

Lemma 3.1. *Let G be a critical minimal subgraph of (G', D) in first standard form with $\gamma = \gamma(G') = |D| \geq 3$. If G contains vertices $x, y \in D$, $l_1, l_2, r_1, r_2 \in V(G) \setminus D$, two edge disjoint paths $P_1 = [x, l_1, r_1, y]$, $P_2 = [x, l_2, r_2, y]$, all neighbors of l_1, r_1 are in $\{x, l_1, r_1, y\}$, and all neighbors of l_2, r_2 are in $\{x, l_2, r_2, y\}$, then we have $\Xi(\gamma) \leq \Xi(\gamma - 1) + 3$.*

PROOF. Let \tilde{G} be the graph which arises from G by deleting l_1, l_2, r_1, r_2 and identifying x with y . Now let $\tilde{D} := D \setminus \{y\}$ and \tilde{H} be an arbitrary minimal orientation of \tilde{G} . Thus we have $\text{diam}_0(\tilde{H}, \tilde{D}) \leq \Xi(\gamma - 1) + 4$, $\text{diam}_1(\tilde{H}, \tilde{D}) \leq \Xi(\gamma - 1) + 2$, and $\text{diam}_2(\tilde{H}, \tilde{D}) \leq \Xi(\gamma - 1)$. We construct an orientation H of G by directing the two paths P_1 and P_2 in opposing directions, and by taking the directions from \tilde{H} . Now we analyze the distance $d_H(u, v)$ in H for all pairs $u, v \in V(G)$. If both u and v are in $\{l_1, l_2, r_1, r_2\}$, then we have $d_H(u, v) \leq 5 \leq \Xi(\gamma - 1) + 3$. If none of u and v is in $\{l_1, l_2, r_1, r_2\}$, then we have $d_H(u, v) \leq d_{\tilde{H}}(u, v) + 3$. In the remaining case we have $d_H(u, v) \leq d_{\tilde{H}}(u, v) + 5$. Thus we have

$$\begin{aligned} \text{diam}_2(H, D) &\leq \max \left\{ \text{diam}_2(\tilde{H}, \tilde{D}) + 3, \text{diam}_1(\tilde{H}, \tilde{D}) + 5, 5 \right\} \leq \Xi(\gamma - 1) + 3, \\ \text{diam}_1(H, D) &\leq \max \left\{ \text{diam}_1(\tilde{H}, \tilde{D}) + 3, \text{diam}_0(\tilde{H}, \tilde{D}) + 5, 5 \right\} \leq \Xi(\gamma - 1) + 1, \text{ and} \\ \text{diam}_0(H, D) &\leq \text{diam}_0(\tilde{H}, \tilde{D}) + 3 \leq \Xi(\gamma - 1) - 1, \end{aligned}$$

which yields $\Xi(\gamma) \leq \Xi(\gamma - 1) + 3$. \square

We remark that Lemma 3.1 corresponds to a graph containing the left graph of Figure 3 as an induced subgraph, where the vertices corresponding to the empty circles have no further neighbors in the whole graph.

Lemma 3.2. *Let G be a critical minimal subgraph of (G', D) in first standard form with $\gamma = \gamma(G') = |D| \geq 3$. If G contains vertices $x, y, z \in D$, four edge disjoint paths $P_1 = [x, v_1, v_2, v_3, y]$, $P_2 = [y, v_4, v_5, v_6, z]$, $P_3 = [x, u_1, u_2, y]$, $P_4 = [y, u_3, u_4, z]$, and all edges being adjacent to vertices in $I := \{v_1, v_2, v_3, v_4, v_5, v_6, u_1, u_2, u_3, u_4\}$ are contained in $P := P_1 \cup P_2 \cup P_3 \cup P_4$, then we have $\Xi(\gamma) \leq \Xi(\gamma - 2) + 7$.*

PROOF. At first we want to determine some structure information on the vertices v_i, u_j and the adjacent edges. We have $f(v_1) = f(u_1) = x$, $f(v_3) = f(v_4) = f(u_2) = f(u_3) = y$, and $f(v_6) = f(u_4) = z$. Since all edges being adjacent to vertices in I are contained in P we have $f(v_2), f(v_5) \in \{x, y, z\}$. Some vertices may have several labels. By $v_i \sim$ we denote the set of labels which correspond to the same vertex as v_i . Similarly we define $u_i \sim$.

Let us at first assume $|I| = 10$, meaning, that each vertex has a unique label. In this case we may consider the edge $\{v_2, f(v_2)\}$ which is not contained in P to see that G would not be a minimal subgraph of (G', D) in first standard form.

Due to the 14 pairwise different edges of P and the information on the values of f we have

- (a) $v_1 \sim \subseteq \{v_1, v_5\}$, $v_3 \sim \subseteq \{v_3, v_5\}$, $v_4 \sim \subseteq \{v_2, v_4\}$, $v_6 \sim \subseteq \{v_2, v_6\}$,
- (b) $u_1 \sim \subseteq \{u_1, v_2, v_5\}$, $u_2 \sim \subseteq \{u_2, v_2, v_5\}$, $u_3 \sim \subseteq \{u_3, v_2, v_5\}$, $u_4 \sim \subseteq \{u_4, v_2, v_5\}$,
- (c) $v_2 \sim \subseteq \{v_2, v_4, v_5, v_6, u_1, u_2, u_3, u_4\}$, $v_5 \sim \subseteq \{v_1, v_2, v_3, v_5, u_1, u_2, u_3, u_4\}$.

Next we assume $|I| = 9$ which means that exactly one vertex in I has two different labels and all other vertices have unique labels.

- (1) If $v_1 = v_5$ then v_2, v_3 , and v_4 could be deleted.
- (2) If $v_3 = v_5$ then v_4 could be deleted.

- (3) If $u_1 = v_2$ then by considering the edge $\{v_5, f(v_5)\} \notin P$ we could conclude that either v_4 or v_6 could be deleted.
- (4) If $u_1 = v_5$ then u_2 could be deleted.
- (5) If $u_2 = v_2$ then by considering the edge $\{v_5, f(v_5)\} \notin P$ we could conclude that either v_4 or v_6 could be deleted.
- (6) If $u_2 = v_5$ then v_4 could be deleted.
- (7) If $v_2 = v_5$ then v_3 and v_4 could be deleted.

Thus the vertices v_1, v_3, u_1, u_2 are unique. Using symmetry we conclude that also the vertices $v_4, v_6, u_3,$ and u_4 are unique. Since we have also dealt with the only left possibility $v_2 = v_5$ we can conclude $|I| \leq 8$.

We proceed similar as in the proof of Lemma 3.1 and let \tilde{G} be the graph arising from G by deleting the vertices u_i, v_i, y and by identifying x and z . Obviously \tilde{G} is bridgeless connected. Now let $\tilde{D} := D \setminus \{y, z\}$ and \tilde{H} be an arbitrary minimal orientation of \tilde{G} . Thus we have $\text{diam}_0(\tilde{H}, \tilde{D}) \leq \Xi(\gamma - 2) - 4$, $\text{diam}_1(\tilde{H}, \tilde{D}) \leq \Xi(\gamma - 2) - 2$, and $\text{diam}_2(\tilde{H}, \tilde{D}) \leq \Xi(\gamma - 2)$.

We construct an orientation H of G by directing the two pairs of paths $(P_1, P_3), (P_2, P_4)$ in opposing directions such that the arcs $[v_3, y], [y, v_4]$ are directed different, by taking the directions from \tilde{H} and by directing remaining edges arbitrarily.

Now we analyze the distance $d_H(u, v)$ in H for all pairs $u, v \in V(G)$. Due to $d_H(x, z), d_H(z, x) \leq 7$, $d_H(y, x), d_H(y, z), d_H(x, y), d_H(z, y) \leq 4$ we have $d_H(u, v) \leq d_{\tilde{H}}(u, v) + 7$ for $u, v \notin I$. Now we consider $d_H(u, v)$ for $u, v \in I \cup \{x, y, z\}$. Due to $L := |I \cup \{x, y, z\}| \leq 11$ we clearly have $d_H(u, v) \leq 10$. We assume $L = 11$ since otherwise we would have $d_H(u, v) \leq 9$. Now we have a closer look at the directed cycle $C := P_1 \circ P_4 \circ P_2 \circ P_3$ of length 14 consisting of 11 vertices. It is not possible to visit all 11 vertices going along edges of the cycle C without visiting a vertex twice. Thus we have $d_H(u, v) \leq 9$ for $u, v \in I \cup \{x, y, z\}$. Summarizing our results gives

$$\begin{aligned} \text{diam}_2(H, D) &\leq \max \left\{ \text{diam}_2(\tilde{H}, \tilde{D}) + 7, \text{diam}_1(\tilde{H}, \tilde{D}) + 9, 9 \right\} \leq \Xi(\gamma - 2) + 7, \\ \text{diam}_1(H, D) &\leq \max \left\{ \text{diam}_1(\tilde{H}, \tilde{D}) + 7, \text{diam}_0(\tilde{H}, \tilde{D}) + 9, 9 \right\} \leq \Xi(\gamma - 2) + 5, \text{ and} \\ \text{diam}_0(H, D) &\leq \text{diam}_0(\tilde{H}, \tilde{D}) + 7 \leq \Xi(\gamma - 2) + 3, \end{aligned}$$

which yields $\Xi(\gamma) \leq \Xi(\gamma - 2) + 7$. □

We remark that Lemma 3.2 corresponds to a graph containing the right graph of Figure 3 two times as an induced subgraph for $x, y, z \in D$ corresponding to the black circle, where the vertices corresponding to the empty circles have no further neighbors in the whole graph.

Lemma 3.3. *Let G be a critical minimal subgraph of (G', D) in first standard form with $\gamma = \gamma(G') = |D| \geq 3$ and x a vertex contained in the dominating set D . If removing x produces at least three connectivity components C_1, C_2, C_3, \dots , then we have*

$$\Xi(\gamma) \leq \max \left\{ \Xi(\gamma - i) + \Xi(i) - 4 : 1 \leq i \leq \gamma - 1 \right\}.$$

PROOF. Let \tilde{C}_i be the induced subgraphs of $V(C_i) \cup \{x\}$ in G . We set $D_i = \{x\} \cup (V(C_i) \cap D)$ and $\gamma_i := |D_i| - 1$ so that we have $1 + \sum_i \gamma_i = \gamma$. Since G is a minimal subgraph we have $\gamma_i \geq 1$ for all i . Now we choose arbitrary minimal orientations \tilde{H}_i of the \tilde{C}_i . Thus we have $\text{diam}_0(\tilde{H}_i, D_i) \leq \Xi(\gamma_i + 1) - 4$, $\text{diam}_1(\tilde{H}_i, D_i) \leq \Xi(\gamma_i + 1) - 2$, and $\text{diam}_2(\tilde{H}_i, D_i) \leq \Xi(\gamma_i + 1)$ for all i . Since \tilde{C}_i and \tilde{C}_j are edge-disjoint for $i \neq j$ we can construct an orientation H of G by taking the directions of the \tilde{H}_i . Now we analyze the distance $d_H(u, v)$ in H for all pairs $u, v \in V(G)$. If u and v are contained in the same component \tilde{C}_i we have $d_H(u, v) = d_{\tilde{H}_i}(u, v)$. If u is contained in \tilde{C}_i and v is contained in \tilde{C}_j , then we

have $d_H(u, v) \leq d_{\tilde{H}_i}(u, x) + d_{\tilde{H}_j}(x, v)$. Thus we have

$$\begin{aligned} \text{diam}_2(H, D) &\leq \max \left\{ \text{diam}_2(\tilde{H}_i, D_i), \text{diam}_1(\tilde{H}_i, D_i) + \text{diam}_1(\tilde{H}_j, D_j) : i \neq j \right\} \\ &\leq \max \left\{ \Xi(\gamma_i + 1), \Xi(\gamma_i + 1) + \Xi(\gamma_j + 1) - 4 : i \neq j \right\} \\ \text{diam}_1(H, D) &\leq \max \left\{ \text{diam}_1(\tilde{H}_i, D_i), \text{diam}_1(\tilde{H}_i, D_i) + \text{diam}_0(\tilde{H}_j, D_j) : i \neq j \right\} \\ &\leq \max \left\{ \Xi(\gamma_i + 1) - 2, \Xi(\gamma_i + 1) + \Xi(\gamma_j + 1) - 6 : i \neq j \right\}, \text{ and} \\ \text{diam}_0(H, D) &\leq \max \left\{ \text{diam}_0(\tilde{H}_i, D_i) + \text{diam}_0(\tilde{H}_j, D_j) : i \neq j \right\} \\ &\leq \max \left\{ \Xi(\gamma_i + 1) + \Xi(\gamma_j + 1) - 8 : i \neq j \right\}. \end{aligned}$$

Since we have at least three connectivity components it holds $\gamma_i + \gamma_j \leq \gamma - 2$ for all $i \neq j$. Using this and $\Xi(n - 1) \leq \Xi(n)$ we conclude $\Xi(\gamma) \leq \max \left\{ \Xi(\gamma - i) + \Xi(i) - 4 : 1 \leq i \leq \gamma - 1 \right\}$. \square

Lemma 3.4. *Let G be a critical minimal subgraph of (G', D) in first standard form with $\gamma = \gamma(G') = |D| \geq 3$ and x a vertex not contained in the dominating set D . If removing x produces at least three connectivity components C_1, C_2, C_3, \dots , then we have*

$$\Xi(\gamma) \leq \max \left\{ \Xi(i) + \Xi(\gamma + 1 - i) - 7, \Xi(i - 1) + \Xi(\gamma + 1 - i) - 4 : 2 \leq i \leq \gamma - 1 \right\}.$$

PROOF. W.l.o.g. let $f(x)$ be contained in C_1 . Let \tilde{C}_1 be the induced subgraph of $V(C_1) \cup \{x\}$ in G and $D_1 = D \cap V(C_1)$. For $i \geq 2$ let \tilde{C}_i be the induced subgraph of $V(C_i) \cup \{x\}$ in G with additional vertices y_i, z_i , additional edges $\{x, y_i\}, \{x, z_i\}, \{y_i, z_i\}$, and $D_i = (V(C_i) \cap D) \cup \{z_i\}$. We set $\gamma_1 = |D_1| \geq 1$ and $\gamma_i = |D_i| - 1 \geq 1$ for $i \geq 2$ so that we have $\sum_i \gamma_i = \gamma$. By \tilde{H}_i we denote an optimal orientation of \tilde{C}_i . W.l.o.g. we assume that in \tilde{H}_1 the edge $\{f(x), x\}$ is directed from $f(x)$ to x and that for $i \geq 2$ in \tilde{H}_i the edges $\{x, y_i\}, \{x, z_i\}, \{y_i, z_i\}$ are directed from x to y_i , from y_i to z_i and from z_i to x . Due to the minimality of the orientations \tilde{H}_i we have $\text{diam}_0(\tilde{H}_1, D_1) \leq \Xi(\gamma_1) - 4$, $\text{diam}_1(\tilde{H}_1, D_1) \leq \Xi(\gamma_1) - 2$, $\text{diam}_2(\tilde{H}_1, D_1) \leq \Xi(\gamma_1)$, and for $i \geq 2$ we have $\text{diam}_0(\tilde{H}_i, D_i) \leq \Xi(\gamma_i + 1) - 4$, $\text{diam}_1(\tilde{H}_i, D_i) \leq \Xi(\gamma_i + 1) - 2$, $\text{diam}_2(\tilde{H}_i, D_i) \leq \Xi(\gamma_i + 1)$.

We construct an orientation H of G by taking the directions of the common edges with the \tilde{H}_i . Now we analyze the distance $d_H(u, v)$ in H for all pairs $u, v \in V(G)$. We only have to consider the cases where u and v are in different connectivity components. Let us first assume $u \in \tilde{C}_i, v \in \tilde{C}_j$ with $i, j \geq 2$. We have

$$d_H(u, v) \leq d_{\tilde{H}_i}(u, x) + d_{\tilde{H}_j}(x, v) \leq d_{\tilde{H}_i}(u, z_i) - 2 + d_{\tilde{H}_j}(z_j, v) - 1,$$

since every directed path from a vertex $u \in V(G)$ to z_i in \tilde{H}_i uses the arcs $[x, y_i], [y_i, z_i]$, and every directed path from z_j to a vertex $v \in V(G)$ in \tilde{H}_j uses the arc $[z_j, x]$. Now let u be in \tilde{C}_1 and v be in \tilde{C}_i with $i \geq 2$. Since the edge $\{f(x), x\}$ is directed from $f(x)$ to x , both in H and in \tilde{H}_1 , we can conclude

$$d_H(u, v) \leq d_{\tilde{H}_1}(u, x) + d_{\tilde{H}_i}(x, v) \leq d_{\tilde{H}_1}(u, f(x)) + 1 + d_{\tilde{H}_i}(z_i, v) - 1.$$

If $u \in \tilde{C}_i$ with $i \geq 2$ and $v \in \tilde{C}_1$, then we similarly conclude

$$d_H(u, v) \leq d_{\tilde{H}_i}(u, x) + d_{\tilde{H}_1}(x, v) \leq d_{\tilde{H}_i}(u, z_i) - 2 + d_{\tilde{H}_1}(x, v).$$

Thus using $\Xi(i-1) \leq \Xi(i)$ for $i \in \mathbb{N}$ and $\gamma_i + \gamma_j \leq \gamma - 1$ for all $i \neq j$ in total we have

$$\begin{aligned}
\text{diam}_2(H, D) &\leq \max \left\{ \text{diam}_2(\tilde{H}_1, D_1), \text{diam}_2(\tilde{H}_i, D_i), \text{diam}_1(\tilde{H}_i, D_i) + \text{diam}_1(\tilde{H}_j, D_j) - 3, \right. \\
&\quad \left. \text{diam}_1(\tilde{H}_1, D_1) + \text{diam}_1(\tilde{H}_i, D_i), \text{diam}_2(\tilde{H}_1, D_1) + \text{diam}_1(\tilde{H}_i, D_i) - 2 \right\} \\
&\leq \max \left\{ \Xi(\gamma - 1), \Xi(\gamma_i + 1) + \Xi(\gamma_j + 1) - 7, \Xi(\gamma_1) + \Xi(\gamma_i + 1) - 4 : 2 \leq i < j \right\} \\
&\leq \max \left\{ \Xi(i) + \Xi(\gamma + 1 - i) - 7, \Xi(i - 1) + \Xi(\gamma + 1 - i) - 4 : 2 \leq i \leq \gamma - 1 \right\} \\
\text{diam}_1(H, D) &\leq \max \left\{ \text{diam}_1(\tilde{H}_1, D_1), \text{diam}_1(\tilde{H}_i, D_i), \text{diam}_0(\tilde{H}_i, D_i) + \text{diam}_1(\tilde{H}_j, D_j) - 3, \right. \\
&\quad \text{diam}_0(\tilde{H}_1, D_1) + \text{diam}_1(\tilde{H}_i, D_i), \text{diam}_1(\tilde{H}_1, D_1) + \text{diam}_0(\tilde{H}_i, D_i), \\
&\quad \left. \text{diam}_2(\tilde{H}_1, D_1) + \text{diam}_0(\tilde{H}_i, D_i) - 2, \text{diam}_1(\tilde{H}_1, D_1) + \text{diam}_1(\tilde{H}_i, D_i) - 2 \right\} \\
&\leq \max \left\{ \Xi(\gamma - 1) - 2, \Xi(\gamma_i + 1) + \Xi(\gamma_j + 1) - 9, \Xi(\gamma_1) + \Xi(\gamma_i + 1) - 6 : 2 \leq i < j \right\} \\
&\leq \max \left\{ \Xi(i) + \Xi(\gamma + 1 - i) - 9, \Xi(i - 1) + \Xi(\gamma + 1 - i) - 6 : 2 \leq i \leq \gamma - 1 \right\} \\
\text{diam}_0(H, D) &\leq \max \left\{ \text{diam}_0(\tilde{H}_1, D_1), \text{diam}_0(\tilde{H}_i, D_i), \text{diam}_0(\tilde{H}_i, D_i) + \text{diam}_0(\tilde{H}_j, D_j) - 3, \right. \\
&\quad \left. \text{diam}_0(\tilde{H}_1, D_1) + \text{diam}_0(\tilde{H}_i, D_i), \text{diam}_1(\tilde{H}_1, D_1) + \text{diam}_0(\tilde{H}_i, D_i) - 2 \right\} \\
&\leq \max \left\{ \Xi(\gamma - 1) - 4, \Xi(\gamma_i + 1) + \Xi(\gamma_j + 1) - 11, \Xi(\gamma_1) + \Xi(\gamma_i + 1) - 8 : 2 \leq i < j \right\} \\
&\leq \max \left\{ \Xi(i) + \Xi(\gamma + 1 - i) - 11, \Xi(i - 1) + \Xi(\gamma + 1 - i) - 8 : 2 \leq i \leq \gamma - 1 \right\},
\end{aligned}$$

which yields $\Xi(\gamma) \leq \max \left\{ \Xi(i) + \Xi(\gamma + 1 - i) - 7, \Xi(i - 1) + \Xi(\gamma + 1 - i) - 4 : 2 \leq i \leq \gamma - 1 \right\}$. \square

Now we are ready to determine the next exact value of $\Xi(\gamma)$:

Lemma 3.5.

$$\Xi(3) = 11.$$

PROOF. The last example from Figure 1 gives $\Xi(3) \geq 11$. Going through the cases of the subgraph construction being described in front of Lemma 2.6 we are able to explicitly construct a finite list of possible subgraphs for $\gamma = 3$. This fall differentiation is a bit laborious but not difficult. We can assume that these graphs G are minimal subgraphs of a suitable pair (G', D) in first standard form. During our construction we can drop all graphs which are not minimal, e. g. graphs containing a chord where no end vertex lies in the dominating set D . Doing this we obtain a list of 24 non-isomorphic minimal subgraphs. In Figure 4 we give suitable orientations for the cases, where we can not apply Lemma 3.1, Lemma 3.2, or Lemma 3.4. \square

Going over the proofs of the previous lemmas again, we can conclude some further, in some sense weaker, reduction results. Similarly as in Lemma 3.2 we can prove:

Lemma 3.6. *Let G be a critical minimal subgraph of (G', D) in first standard form with $\gamma = \gamma(G') = |D| \geq 3$. If G contains vertices $x, y \in D$, two edge disjoint paths $P_1 = [x, u_1, u_2, u_3, y]$, $P_2 = [x, v_1, v_2, y]$, and all edges being adjacent to vertices in $I := \{u_1, u_2, u_3, v_1, v_2\}$ are contained in $P_1 \cup P_2$, then we have $\Xi(\gamma) \leq \Xi(\gamma - 1) + 4$.*

Lemma 3.7. *Let G be a critical minimal subgraph of (G', D) in first standard form with $\gamma = \gamma(G') = |D| \geq 3$ and x a vertex contained in the dominating set D . If removing x produces two connectivity*

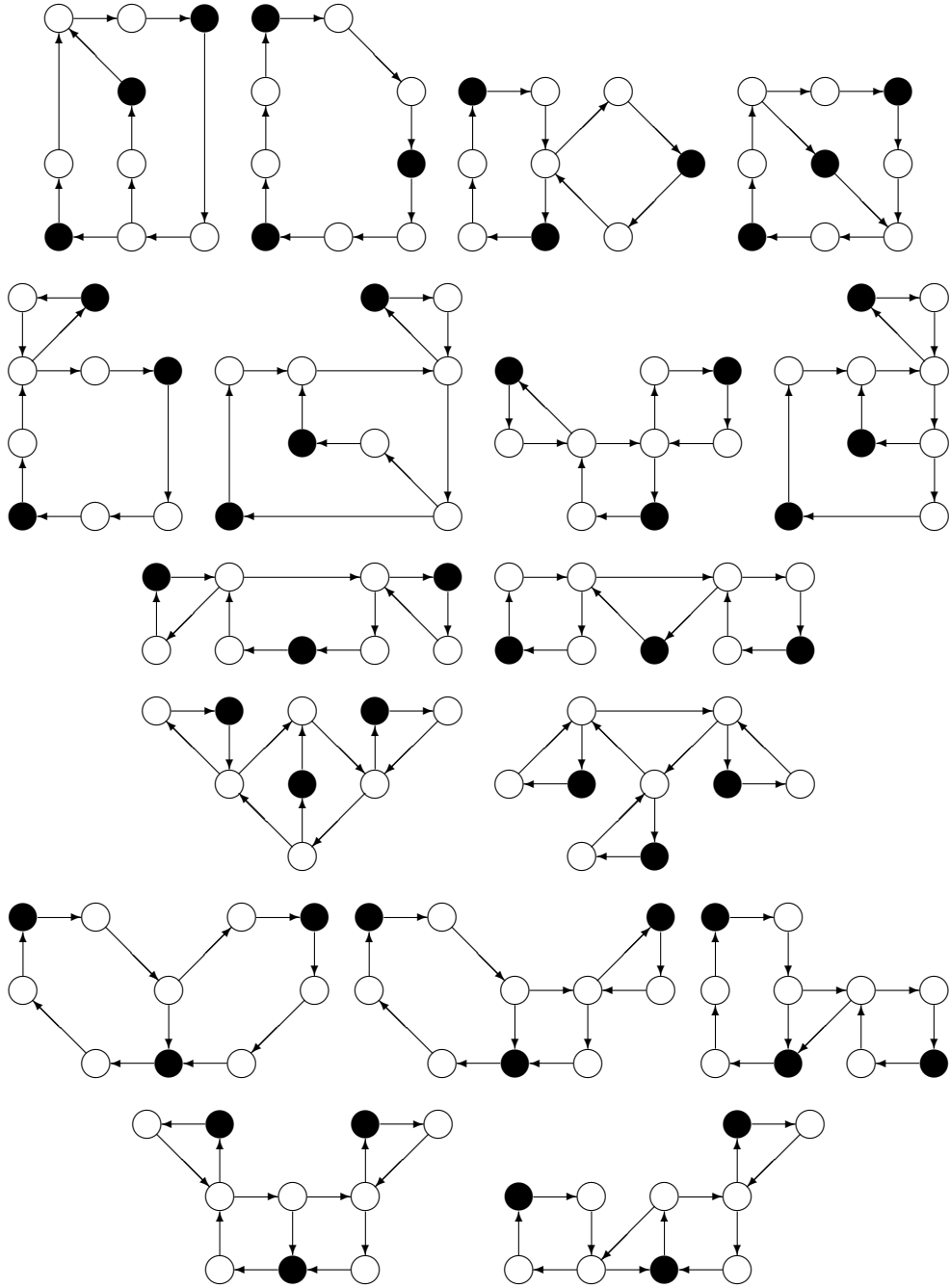

FIGURE 4. The orientations for the proof of Lemma 3.5.

components C_1 and C_2 then we have

$$\Xi(\gamma) \leq \max \left\{ \Xi(\gamma + 1 - i) + \Xi(i) - 4 : 2 \leq i \leq \gamma - 1 \right\}.$$

PROOF. We can rephrase most of the proof of Lemma 3.3. Our estimations on $\text{diam}_i(H, D)$ remain valid. Since we only have two connectivity components we do not have $\gamma_i + \gamma_j \leq \gamma - 2$ for $i \neq j$. Instead we have $\gamma_1 + \gamma_2 = \gamma - 1$ and $\gamma_1, \gamma_2 \leq \gamma - 2$. Combining this with $\Xi(n-1) \leq \Xi(n)$ we obtain the stated upper bound. \square

Lemma 3.8. *Let G be a critical minimal subgraph of (G', D) in first standard form with $\gamma = \gamma(G') = |D| \geq 3$ and x a vertex not contained in the dominating set D . If removing x produces at least two connectivity components C_1, C_2 where $f(x) \in C_1$ and $|V(C_1) \cap D| \geq 2$ then we have*

$$\Xi(\gamma) \leq \max \left\{ \Xi(i) + \Xi(\gamma + 1 - i) - 4 : 2 \leq i \leq \gamma - 1 \right\}.$$

PROOF. We can rephrase most of the proof of Lemma 3.4. Using $\Xi(i-1) \leq \Xi(i)$ for all $i \in \mathbb{N}$ and the fact that we have exactly two connectivity components C_1 and C_2 yields

$$\begin{aligned} \text{diam}_2(H, D) &\leq \max \left\{ \Xi(\gamma - 1), \Xi(\gamma_1) + \Xi(\gamma_2 + 1) - 4 \right\} \\ \text{diam}_1(H, D) &\leq \max \left\{ \Xi(\gamma - 1) - 2, \Xi(\gamma_1) + \Xi(\gamma_2 + 1) - 6 \right\} \\ \text{diam}_0(H, D) &\leq \max \left\{ \Xi(\gamma - 1) - 4, \Xi(\gamma_1) + \Xi(\gamma_2 + 1) - 8 \right\}. \end{aligned}$$

Due to $\Xi(i-1) \leq \Xi(i)$, $2 \leq \gamma_1 \leq \gamma - 1$, and $1 \leq \gamma_2 \leq \gamma - 1$ we have

$$\Xi(\gamma) \leq \max \left\{ \Xi(i) + \Xi(\gamma + 1 - i) - 4 : 2 \leq i \leq \gamma - 1 \right\}.$$

\square

We would like to remark that Lemmas 3.1, 3.2, 3.3, 3.4 can be used in an induction proof of Conjecture 1.4, whereas Lemmas 3.6, 3.7, 3.8 can only be used in an induction proof of Theorem 1.3.

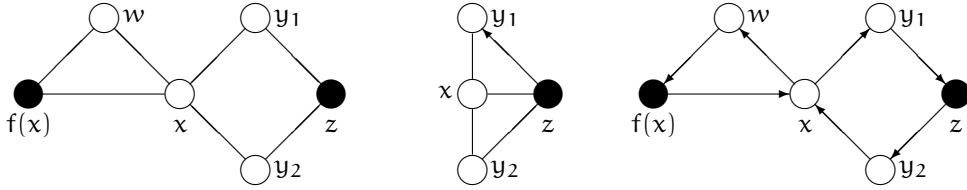

FIGURE 5. The situation of Lemma 3.9 if we can not apply Lemma 3.8.

In order to prove Theorem 1.3 we need some further reduction Lemmas.

Lemma 3.9. *Let G be a critical minimal subgraph of (G', D) in first standard form with $\gamma = \gamma(G') = |D| \geq 3$ and x a vertex not contained in the dominating set D . If removing x produces at least two connectivity components C_1, C_2 , where $f(x) \in C_1$ and there exist $y_1 \neq y_2 \in V(G) \setminus D$ fulfilling $f(y_1) = f(y_2)$ and $\{x, y_1\}, \{x, y_2\} \in E(G)$ then we either can apply Lemma 3.8 or we have $\Xi(\gamma) \leq \Xi(\gamma - 1) + 4$.*

PROOF. If $|V(C_1) \cap D| \geq 2$ we can apply Lemma 3.8 thus we may assume $|V(C_1) \cap D| = 1$. Since G is a minimal subgraph, we have $V(C_1) = \{f(x), w\}$ and the neighbors of $f(x)$ and w in G are contained in $\{f(x), w, x\}$. As an abbreviation we set $f(y_1) = f(y_2) = z \in D$. See the left drawing in Figure 5 for a graphical representation of the situation. Now we consider the subgraph \tilde{C}_2 consisting of the induced subgraph of $V(C_2) \cup \{x\}$ with the additional edge $\{x, f(y_1)\}$. Let H_2 be an optimal orientation of \tilde{C}_2 , where we assume that the arc $[z, y_1]$ is directed from z to y_1 , see the middle graph of Figure 5. Now we construct an orientation H of G by taking the directions from H_2 and redirecting some edges. We direct x to w , w to $f(x)$, $f(x)$ to x to y_1 , y_1 to z , z to y_2 , and y_2 to x , see the right drawing of Figure 5.

Now we analyze the distance $d_H(a, b)$ between two vertices in $V(G)$. If a and b are both in \tilde{C}_2 , then we can consider a shortest path P in H_2 . It may happen that P uses some of the redirected edges. In this case P contains at least two vertices from $\{x, y_1, y_2, z\}$. If P uses more than two vertices from $\{x, y_1, y_2, z\}$ then we only consider those two vertices which have the largest distance on P . Looking at our redirected edges in H we see, the distance between two such vertices is at most three, so that we have $d_H(a, b) \leq d_{H_2}(a, b) + 3$ in this case.

Now let b be in \tilde{C}_2 . We consider a shortest path P in H_2 from z to b . In H we have $d_H(f(x), z) \leq 3$ by considering the path $[f(x), x, y_1, z]$. Since $d_H(z, y_2) = 1$ we have $d_H(f(x), b) \leq d_{H_2}(z, b) + 4$. Similarly we obtain $d_H(w, b) \leq d_{H_2}(z, b) + 5$. With $D_2 = D \setminus \{f(x)\}$ the set D_2 is a dominating set of \tilde{C}_2 and we can check that $|D_2| = \gamma(\tilde{C}_2)$ holds. Since $z \in D_2$ and H_2 is an optimal orientation, for $b_1 \in D_2, b_2 \notin D_2$ we have $d_{H_2}(z, b_1) \leq \Xi(\gamma - 1) - 4$ and $d_{H_2}(z, b_2) \leq \Xi(\gamma - 1) - 2$ yielding $d_H(f(x), b_1) \leq \Xi(\gamma - 1), d_H(f(x), b_2) \leq \Xi(\gamma - 1) + 2, d_H(w, b_1) \leq \Xi(\gamma - 1) + 1, and $d_H(w, b_2) \leq \Xi(\gamma - 1) + 3$. This is compatible with $\Xi(\gamma) \leq \Xi(\gamma - 1) + 4$ due to $f(x), b_1 \in D$ and $w, b_2 \notin D$.$

Now let a be in \tilde{C}_2 . we consider a shortest path P in H_2 from a to z . In H we have $d_H(z, f(x)) \leq 4$ by considering the path $[z, y_2, x, w, f(x)]$. Since P can not use an arc from y_1 to z (this arc is directed in the opposite direction in H_2) either P contains a vertex in $\{x, y_2\}$ or P also exists in H , so that we have $d_H(a, f(x)) \leq d_{H_2}(a, z) + 4$. Similarly we obtain $d_H(a, w) \leq d_{H_2}(a, z) + 3$. Since H_2 we conclude similarly as in the above paragraph that all distances are compatible with $\Xi(\gamma) \leq \Xi(\gamma - 1) + 4$. \square

Lemma 3.10. *Let G be a minimal subgraph of a pair (G', D) in first standard form. If there exist $z_1, z_2 \in V(G) \setminus D$ with $f(z_1) = f(z_2)$ and $\{z_1, z_2\} \in E(G)$, then either z_1 or z_2 is a cut vertex.*

PROOF. If z_1 has no other neighbors besides z_2 and $x := f(z_1)$ then either z_2 is a cut vertex or z_1 can be deleted from G without destroying the properties of Definition 2.7. We assume that whether z_1 nor z_2 is a cut vertex. Thus both z_1 and z_2 have further neighbors y_1 and y_2 , respectively. Since $\{z_1, z_2\}$ can not be deleted we have $y_1 \neq y_2$. Let P_1 be a shortest path from y_1 to z_2 in $G \setminus \{z_1\}$. Since $\{z_1, z_2\}$ can not be deleted P_1 contains the edge $\{x, z_2\}$. Similarly there exists a shortest path from y_2 to z_1 containing the edge $\{x, z_1\}$. Thus in the end the existence of P_1 and P_2 shows that $\{z_1, z_2\}$ could be deleted, which is a contradiction to the minimality of G . \square

Lemma 3.11. *Let G be a minimal subgraph of a pair (G', D) in first standard form. Let x, y_1, y_2 be three vertices not in the dominating set D with $\{x, y_1\}, \{x, y_2\} \in E(G)$ and $f(y_1) \neq f(x) \neq f(y_2)$ either one vertex of x, y_1, y_2 is a cut vertex, or $f(y_1) \neq f(y_2)$.*

PROOF. We assume as contrary that none of x, y_1, y_2 is a cut vertex and $f(y_1) = f(y_2)$. Now we consider $G \setminus \{x\}$, which must be connected. Thus there must exist a path P connecting $f(x)$ to $f(y_1) = f(y_2)$ and either one of the edges $\{x, y_1\}, \{x, y_2\}$ is a chord or one of the vertices y_1, y_2 could be deleted from G , which is a contradiction to the minimality of G . \square

4. PROOF OF THE MAIN THEOREM

In this section we want to prove Theorem 1.3. We use the techniques of induction on $\gamma(G)$ and minimal counter examples with respect to $\gamma(G)$.

Definition 4.1. We call a minimal subgraph G of (G', D) in first standard form a minimal counter example to Theorem 1.3 if we have $\max \left\{ \text{diam}_0(H, D) + 4, \text{diam}_1(H, D) + 2, \text{diam}_2(H, D) \right\} > 4\gamma$ for a minimal orientation H and $\gamma = |D|$ is minimal with this property.

Lemma 4.2. *Let G be a minimal subgraph of (G', D) in first standard form which is a minimal counter example to Theorem 1.3, then there can not exist an elementary cycle $C = [v_0, \dots, v_{3k} = v_0]$ in G with $k \geq 2$ and the $v_{3j} \in D$ for all $0 \leq j < k$.*

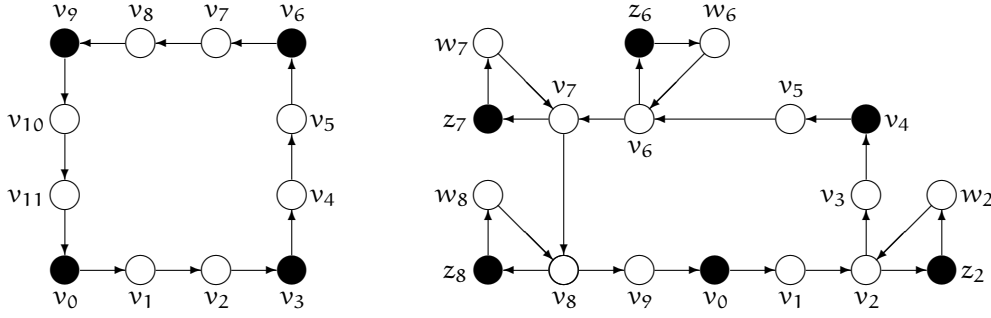

FIGURE 6. The situation of Lemma 4.2 and the situation of Lemma 4.3.

PROOF. We assume the existence of such a cycle C , see the left graph in Figure 4.2 for an example, and consider another graph \tilde{G} arising from G by:

- (1) deleting the edges of C ,
- (2) deleting the vertices v_{3j} for $0 < j < k$,
- (3) inserting vertices u_j and edges $\{v_0, v_j\}, \{v_0, u_j\}, \{u_j, v_j\}$ for all $0 < j < 3k$ with $3 \nmid j$, and by
- (4) identifying all vertices $v_{3j} \in G$ with the vertex $v_0 \in \tilde{G}$, meaning that we replace edges $\{v_{3j}, x\}$ in G by edges $\{v_0, x\}$ in \tilde{G} .

We remark that this construction does not produce multiple edges since (G', D) is in first standard form. The set $\tilde{D} := D \setminus \{v_3, v_6, \dots, v_{3k-3}\}$ is a dominating set of \tilde{G} with $|\tilde{D}| = |D| - k + 1$. Let \tilde{H} be a minimal orientation of (\tilde{G}, \tilde{D}) . We construct an orientation H of G by taking over the directions of all common edges with \tilde{H} and by orienting the edges of C from v_j to v_{j+1} , see the left graph in Figure 4.2.

Now we analyze the distances in H . For brevity we set $I := \{v_{3j} : 0 \leq j < k\}$ (these are the vertices in G which are associated with v_0 in \tilde{G}). The distance of two vertices in I in the orientation H is at most $3k - 3$ and the distance of two vertices in $V(C)$ is at most $3k - 1$. Thus we may assume $|D| > k$. Let a, b be vertices in $V(G)$.

- (1) If a and b are elements of $\{v_j : 0 \leq j < 3k\}$ then we have $d_H(a, b) \leq 3k - 1 < 4|D| - 4$.
- (2) If a and b are not in I then we consider a shortest path \tilde{P} in \tilde{H} connecting a and b .
- (3) If $a \in I$ and $b \notin I$ then we consider a shortest path \tilde{P} in \tilde{H} connecting v_0 and b .
- (4) The case $a \notin I$ and $b \in I$ then we consider a shortest path \tilde{P} in \tilde{H} connecting a and v_0 .

Let \tilde{P} be an arbitrary shortest path in \tilde{H} connecting a and b . It may happen that in H this path \tilde{P} does not exist since it may contain the vertex v_0 corresponding to two different vertices v_{3i} and v_{3j} in G or may contain one of the edges $\{v_0, v_j\}, \{v_0, u_j\}$, or $\{u_j, v_j\}$ with $3 \nmid j$.

Now we want to construct a path P which does connect a and b in H . The path \tilde{P} may use one of the edges $\{v_0, v_j\}, \{v_0, u_j\}$, or $\{u_j, v_j\}$ with $3 \nmid j$. Deleting all these edges decomposes \tilde{P} in at least two parts $\tilde{P}_1, \dots, \tilde{P}_m$ with $|\tilde{P}_1| + |\tilde{P}_m| \leq |\tilde{P}| - 1$. Using a suitable segment \tilde{C} of the cycle C we obtain a path $P = \tilde{P}_1 \cup \tilde{C} \cup \tilde{P}_m$ of length at most $|\tilde{P}_1| + |\tilde{P}_m| + |\tilde{C}| \leq |\tilde{P}| + 3k - 2$. If \tilde{P} does not use one of these edges then it can only happen that v_0 is used in \tilde{P} corresponding to two different vertices v_{3i} and v_{3j} in G . In this case we can use a suitable segment \tilde{C} of the cycle C , which starts and ends in a vertex of I , to obtain a path P connecting a and b in H of length at most $|\tilde{P}| + 3k - 3$.

Now we are ready to prove that G is not a counter example. If $\gamma(\tilde{G}) < |\tilde{D}|$ then we have $\text{diam}(\tilde{H}) \leq 4 \cdot |\tilde{D}| - 4 = 4 \cdot |D| - 4k$ due to the minimality of G . In each of the cases (1)-(4) we have $d_H(a, b) \leq 4 \cdot |D| - k - 2 \leq 4 \cdot |D| - 4$ for all $a, b \in G$. Otherwise we have $\gamma(\tilde{G}) = |\tilde{D}|$ and \tilde{D} is a minimal

dominating set of \tilde{G} . In this case we have

$$\begin{aligned}
\text{diam}_2(H, D) &\leq \max \left\{ \text{diam}_2(\tilde{H}, \tilde{D}) + 3k - 2, \text{diam}_1(\tilde{H}, \tilde{D}) + 3k - 1, 3k - 1 \right\} \\
&\leq 4 \cdot |D| - k + 2 \\
&\leq 4 \cdot |D| \\
\text{diam}_1(H, D) &\leq \max \left\{ \text{diam}_1(\tilde{H}, \tilde{D}) + 3k - 2, \text{diam}_0(\tilde{H}, \tilde{D}) + 3k - 1, 3k - 1 \right\} \\
&\leq 4 \cdot |D| - k \\
&\leq 4 \cdot |D| - 2 \\
\text{diam}_0(H, D) &\leq \max \left\{ \text{diam}_0(\tilde{H}, \tilde{D}) + 3k - 2, 3k - 3 \right\} \\
&\leq 4 \cdot |D| - k - 2 \\
&\leq 4 \cdot |D| - 4
\end{aligned}$$

□

Lemma 4.3. *Let G be a minimal subgraph of (G', D) in first standard form which is a minimal counter example to Theorem 1.3, then there can not exist an elementary cycle $C = [v_0, \dots, v_l = v_0]$ in G with the following properties:*

- (1) $v_0 \in D$,
- (2) $|V(C) \cap D| \geq 2$,
- (3) $l \geq 6$, and
- (4) if $v_j \notin D$ then either $f(v_j) \in \{v_{j-1}, v_{j+1}\}$ or v_j is a cut vertex in G where the component containing $f(v_j)$ contains exactly one vertex of D .

PROOF. We assume the existence of such a cycle C . By y we denote the number of cut vertices v_j in C and by Y the corresponding set. For all $v \in Y$ we have $f(v) \notin C$ since otherwise we could apply Lemma 3.8. If $e = \{v', v''\}$ would be a chord of C then $|\{v', v''\} \cap D| = 1$ since (G', D) is in first standard form and G is a minimal subgraph, which especially means that we can not delete the edge e . We assume w.l.o.g. $v' \in D$ and conclude $f(v'') = v'$. Thus v'' is not a cut vertex and due to property (4) the edge e is not a chord. Finally we conclude that C is chordless. For $y = 0$ we would have $v_{3j} \in D$ due to $l \geq 6$ and the property $f(v_j) \in \{v_{j-1}, v_{j+1}\}$ for vertices $v_j \notin D$. Thus we may assume $y \geq 1$ since otherwise we could apply Lemma 4.2. For each $v_j \in Y$ we set $z_j = f(v_j) \notin V(C)$ and denote by $w_j \in V(G) \setminus (V(C) \cup D)$ the vertex which is adjacent to v_j and z_j . By k we denote the number of vertices v_j in $V(C)$ which are also contained in D . Due to condition (2) we have $k \geq 2$. The two neighbors on the cycle C of a vertex in Y both are not contained in D . For a vertex $v \in V(C) \setminus (D \cup Y)$ one neighbor on C is $f(v)$ and the other neighbor lies in $V(C) \setminus D$. Thus the length $|C|$ of the cycle is given by $3k + y \geq 7$. On the right hand side of Figure 4.2 we have depicted an example with $k = 2$ and $y = 4$.

Now we consider another graph \tilde{G} arising from G by:

- (1) deleting the edges of C ,
- (2) deleting the vertices $\left(\{z_j, w_j : 0 < j < l\} \cup (V(C) \cap D) \right) \setminus \{v_0\}$,
- (3) inserting vertices u_j and edges $\{v_0, v_j\}, \{v_0, u_j\}, \{u_j, v_j\}$ for all $0 < j < l$ with $v_j \notin D$, and by
- (4) identifying all vertices $v_j \in D$ with the vertex $v_0 \in \tilde{G}$, meaning that we replace edges $\{v_j, x\}$ in G by edges $\{v_0, x\}$ in \tilde{G} .

We remark that this construction does not produce multiple edges since (G', D) is in first standard form. The set $\tilde{D} := D \setminus \{v_1, \dots, v_{l-1}, z_1, \dots, z_{l-1}\}$ is a dominating set of \tilde{G} with $|\tilde{D}| = |D| - k - y + 1$. Let \tilde{H} be an minimal orientation of (\tilde{G}, \tilde{D}) . We construct an orientation H of G by taking over the

directions of all common edges with \tilde{H} and by orienting the edges of C from v_j to v_{j+1} . The missing edges corresponding to z_j and w_j are oriented from v_j to z_j , from z_j to w_j , and from w_j to v_j , see the graph on the right hand side of Figure 4.2. For brevity we set $A = V(C) \cup \{w_j, z_j : 0 < j < l\}$.

Now we analyze the distances in H . For $a_1, b_1 \in A$ we have $d_H(a_1, b_1) \leq 3k + y + 3$, for $a_2, b_2 \in V(C)$ we have $d_H(a_2, b_2) \leq 3k + y - 1$, and for $a_3, b_3 \in V(C) \cap D$ we have $d_H(a_3, b_3) \leq 3k + y - 3$. Thus we may assume $|D| > k + y$. Let a, b be vertices in $V(G)$.

- (1) If a and b are elements of A then we have $d_H(a, b) \leq 3k + y + 3 < 4|D| - 4$.
- (2) If a and b are not in A then we consider a shortest path \tilde{P} in \tilde{H} connecting a and b .
- (3) If $a \in A$ and $b \notin A$ then we consider a shortest path \tilde{P} in \tilde{H} connecting v_0 and b .
- (4) The case $a \notin A$ and $b \in A$ then we consider a shortest path \tilde{P} in \tilde{H} connecting a and v_0 .

Let \tilde{P} be a shortest path in \tilde{H} connecting two vertices a and b . Similarly as in the proof of Lemma 4.2 we construct a path P in H connecting a and b . Doing the same analysis we obtain $|P| \leq |\tilde{P}| + 3k + y - 2$. Starting or ending at a vertex z_i or w_i increases the length by at most 2.

If $\gamma(\tilde{G}) < |\tilde{D}| = |D| - k - y + 1$ then we would have $d_H(a, b) \leq 4|D| - k - 3y + 1 \leq 4|D| - 4$. Thus we may assume $\gamma(\tilde{G}) = |\tilde{D}| = |D| - k - y + 1$, meaning that \tilde{D} is a minimal dominating set. With this clearly we have $d_{\tilde{H}}(v_0, b), d_{\tilde{H}}(a, v_0) \leq 4 \cdot |\tilde{D}| - 2$ for all $a, b \in \tilde{G}$ and $d_{\tilde{H}}(v_0, b'), d_{\tilde{H}}(a', v_0) \leq 4 \cdot |\tilde{D}| - 4$ for all $a', b' \in \tilde{D}$.

For $k + y \geq 3$ and $|D| \geq k + y + 1$ we have

$$\begin{aligned} \text{diam}_2(H, D) &\leq \max \left\{ \text{diam}_2(\tilde{H}, \tilde{D}) + 3k + y - 2, \text{diam}_1(\tilde{H}, \tilde{D}) + 3k + y, 3k + y + 3 \right\} \\ &\leq 4 \cdot |D| - k - 3y + 2 \\ &\leq 4 \cdot |D| \\ \text{diam}_1(H, D) &\leq \max \left\{ \text{diam}_1(\tilde{H}, \tilde{D}) + 3k + y, \text{diam}_0(\tilde{H}, \tilde{D}) + 3k + y, 3k + y + 3 \right\} \\ &\leq 4 \cdot |D| - k - 3y + 2 \\ &\leq 4 \cdot |D| - 2 \\ \text{diam}_0(H, D) &\leq \max \left\{ \text{diam}_0(\tilde{H}, \tilde{D}) + 3k + y, 3k + y + 3 \right\} \\ &\leq 4 \cdot |D| - k - 3y \\ &\leq 4 \cdot |D| - 4 \end{aligned}$$

□

Now we are ready to prove Theorem 1.3:

PROOF.(of Theorem 1.3)

Let G be a minimal subgraph of (G', D) in first standard form which is a minimal counter example to Theorem 1.3. Due to Lemma 2.6 and Lemma 3.5 we can assume $|D| \geq 4$. We show that we have $|V(G)| \leq 4 \cdot (|D| - 1) + 1$. In this case we can utilize an arbitrary orientation H of G . Since a shortest path uses every vertex at most once we would have $\text{diam}(H) \leq 4 \cdot (|D| - 1)$. Applying Lemma 2.5 we conclude $\text{diam}_{\min}(G') \leq 4 \cdot |D| = 4 \cdot \gamma(G')$, which is a contradiction to G being a minimal counter example to Theorem 1.3 and instead proves this theorem.

At first we summarize some structure results for minimal counter examples to Theorem 1.3.

- (1) We can not apply one of the Lemmas 3.7, 3.3, 3.4, 3.8, or 3.10. So if $v \in V(G)$ is a cut vertex we have $v \notin D$ and there exists a unique vertex $t(v) \notin D$ such that we have $\{v, f(v)\}, \{f(v), t(v)\}, \{t(v), v\} \in E(G)$ and all neighbors of $f(v), t(v)$ are contained in $\{f(v), t(v), v\}$.
- (2) Due to Lemma 3.9, Lemma 3.11, and (1) there do not exist pairwise different vertices $x, y_1, y_2 \in V(G) \setminus D$ with $\{x, y_1\}, \{x, y_2\} \in E(G)$ and $f(y_1) = f(y_2)$.

(3) We can not apply Lemma 4.2 or Lemma 4.3 on G .

In order to bound $|V(G)|$ from above we perform a technical trick and count the number of vertices of a different graph \tilde{G} . Therefore we label the cut vertices of G by v_1, \dots, v_m . With this we set

$$\tilde{D} = \left(D \cup \{v_i : 1 \leq i \leq m\} \right) \setminus \{f(v_i) : 1 \leq i \leq m\}.$$

The graph \tilde{G} arises from G by deleting the $f(v_i), t(v_i)$ for $1 \leq i \leq m$ and by replacing the remaining edges $\{v_i, x\}$ by a pair of two edges $\{v_i, y_{x,i}\}, \{y_{x,i}, x\}$, where the $y_{x,i}$ are new vertices. We have $|\tilde{D}| = |D|$, $|V(\tilde{G})| \geq |V(G)|$, the set \tilde{D} is a dominating set of \tilde{G} , and \tilde{G} is a subgraph of a suitable pair in first standard form. If \tilde{G} would not be a minimal subgraph than also G would not be a minimal subgraph. We have the following structure results for \tilde{G} :

- (a) There do not exist two vertices $u, v \in V(\tilde{G}) \setminus \tilde{D}$ with $\{u, v\} \in E(\tilde{G})$ and $f(u) = f(v)$.
- (b) There do not exist pairwise different vertices $x, y_1, y_2 \in V(\tilde{G}) \setminus \tilde{D}$ with $\{x, y_1\}, \{x, y_2\} \in E(\tilde{G})$ and $f(y_1) = f(y_2)$.
- (c) We can not apply Lemma 4.2 or Lemma 4.3 on \tilde{G} .

Since our construction of \tilde{G} has removed all such configurations (a) holds. If in (b) $f(y_1) = f(y_2)$ is an element of D then such a configuration also exists in G , which is a contradiction to (2). If $f(y_1)$ corresponds to a v_i in G , then y_1 and y_2 would correspond to two new vertices $y_{i,e}$ and $y_{i,e'}$. In this case we would have a double edge from x to v_i in G , which is not true. Thus (b) holds. Since all vertices in $\tilde{D} \setminus D$ correspond to cut vertices in G also (c) holds.

In order to prove $|V(\tilde{G})| \leq 4 \cdot (|\tilde{D}| - 1) + 1$ we construct a tree T fulfilling

- (i) $\tilde{D} \subseteq V(T)$ and
- (ii) if $v_1 \in V(T) \setminus \tilde{D}$ then we have $\{f(v_1), v_1\} \in E(T)$.

Therefore we iteratively construct trees T_k for $1 \leq k \leq |\tilde{D}|$. The tree T_1 is composed of a single vertex $x_1 \in \tilde{D}$. The tree T_1 clearly fulfills condition (ii). To construct T_{k+1} from T_k we find a vertex x_{k+1} in $\tilde{D} \setminus V(T_k)$ with the minimum distance to T_k . The tree T_{k+1} is the union of T_k with a shortest path P_{k+1} from x_{k+1} to T_k . Since \tilde{D} is a dominating set this path P_{k+1} has length at most three. Since \tilde{G} is a subgraph of a suitable pair in first standard form P_{k+1} has length at least two. For $P_{k+1} = [x_{k+1}, v_1, v_2]$ we have $v_1, v_2 \notin \tilde{D}$ due to the first standard form and $f(v_1) = x_{k+1}, v_2 \in V(T_k)$. Since condition (ii) is fulfilled for T_k it is also fulfilled for T_{k+1} in this case. In the remaining case we have $P_{k+1} = [x_{k+1}, v_1, v_2, v_3]$ with $v_1, v_2 \notin V(T_k), v_1, v_2 \notin \tilde{D}$, and $v_3 \in V(T_k)$. If $f(v_2)$ would not be contained in $V(T_k)$ then $[f(v_2), v_2, v_3]$ would be a shorter path connecting $f(v_2)$ to T_k . Thus we have $f(v_2) \in V(T_k)$ and we may assume $v_3 = f(v_2)$. (We may simply consider the path $[x_{k+1}, v_1, v_2, f(v_2)]$ instead of P_{k+1} .) Due to $x_{k+1} \notin V(T_k)$ and T_k fulfilling condition (ii), these conditions are also fulfilled for T_{k+1} . In the end we obtain a tree $T_{|\tilde{D}|}$ fulfilling condition (i) and condition (ii). By considering the paths P_k we conclude $|V(T)| \leq |\tilde{D}| + 2(|\tilde{D}| - 1)$.

Clearly we have some alternatives during the construction of $T_{|\tilde{D}|}$. Now we assume that T is a subtree of \tilde{G} fulfilling conditions (i) and (ii), and having the maximal number of vertices. In the next step we want to prove some properties of the vertices in T .

Let $v \in \tilde{D}$ and let $u \in V(\tilde{G}) \setminus V(T)$ be a neighbor of v in \tilde{G} . We prove that every neighbor u' of u in \tilde{G} is contained in $V(T)$. Clearly we have $u' \notin \tilde{D}$. Due to (a) we have $f(u') \neq v$. If $u' \notin V(T)$ then adding the edges $A := \{v, u\}, \{u, u'\}, \{u', f(u')\}$ gives an elementary cycle $C = [v_0, \dots, v_l]$ in $(V(T) \cup \{u, u'\}, E(T) \cup A)$, where $v_0 = v_l$ and $l \geq 6$. Since we can not apply Lemma 4.2 there exists an index j (reading the indices modulo l) fulfilling

$$v_j \in \tilde{D} \quad \text{and} \quad v_{j+1}, v_{j+2}, v_{j+3} \in V(T) \setminus \tilde{D}.$$

Since the edge $\{v_{j+1}, v_{j+2}\}$ is contained in $E(T)$ also the edge $\{v_{j+2}, f(v_{j+2})\}$ is contained in $E(T)$. Similarly we conclude that the edge $\{v_{j+3}, f(v_{j+3})\}$ is contained in $E(T)$. If v_{j+1} has no further neighbors besides v_j and v_{j+2} in T then

$$T' := \left((V(T) \cup \{u, u'\}) \setminus \{v_{j+1}\}, (E(T) \cup A) \setminus \left\{ \{v_j, v_{j+1}\}, \{v_{j+1}, v_{j+2}\} \right\} \right)$$

would be a subtree of \tilde{G} fulfilling the conditions (i) and (ii) with a larger number of vertices than T . Thus such an u' can not exist in this case. If v_{j+1} has further neighbors in T , then deleting the edge $\{v_{j+1}, v_{j+2}\}$ and adding the edges and vertices of A would also yield a subtree of \tilde{G} fulfilling the conditions (i) and (ii) with a larger number of vertices than T .

The same statement also holds for $v \in V(T) \setminus \tilde{D}$ since we may consider $f(u)$ instead v . Thus in \tilde{G} we have $\{u, v\} \cap V(T) \neq \emptyset$ for every edge $\{u, v\} \in E(\tilde{G})$.

For a graph K and a vertex $v \in V(K)$ we denote by $S(K, v)$ the uniquely defined maximal bridgeless connected subgraph of K containing v . If every edge being adjacent to v is a bridge or v do not have any edges, then S consists only of vertex v . We remark that $u \in S(K, v)$ is an equivalence relation \sim_K for all vertices $u, v \in V(K)$. By F we denote the set of vertices in $V(T)$ which are either contained in \tilde{D} or have a degree in $V(T)$ of at least three. We have

$$|V(T)| + |F| \leq 4 \cdot |\tilde{D}| - 2,$$

which can be proved by induction on $|V(T_k)| + |F \cap V(T_k)| \leq 4 \cdot k - 2$ for $1 \leq k \leq |\tilde{D}|$. Clearly we have $|V(T_1)| + |F \cap V(T_1)| = 2 \leq 4 \cdot 2 - 2$. The tree T_{k+1} arises from T_k by adding a path P_{k+1} of length at most three. If $|P_{k+1}| = 3$ then we have $F \cap V(T_{k+1}) = (F \cap V(T_k)) \cup \{x_{k+1}\}$ and $|V(T_{k+1})| \leq |V(T_k)| + 3$. For $|P_{k+1}| = 2$ we have $|V(T_{k+1})| \leq |V(T_k)| + 2$ and $|F \cap V(T_{k+1})| \leq |F \cap V(T_k)| + 2$.

For a graph K containing T as a subgraph we denote by $N(K)$ the number $\left| \{S(K, v) : v \in F\} \right|$ of equivalence classes of \sim_K . Since T is a tree we have $N(T) = |F|$. Now we recursively construct a sequence of graphs G_i for $1 \leq i \leq |F|$ fulfilling

$$|V(G_i)| + N(G_i) \leq 4 \cdot |\tilde{D}| - 2, \quad N(G_i) \leq i, \quad \text{and } T \subseteq G_i \subseteq \tilde{G}. \quad (2)$$

This yields a graph G_1 containing at most $4 \cdot |\tilde{D}| - 3$ vertices, where each two elements of \tilde{D} are connected by at least two edge disjoint paths. So either we have $|V(\tilde{G})| \leq 4 \cdot |\tilde{D}| - 3$ or \tilde{G} and G are not minimal subgraphs.

During the following analysis we often delete a vertex v or an edge e from the tree T in such a way that it decomposes in exactly two subtrees T^1 and T^2 . Since T contains no cut vertices there exists a path M in \tilde{G} without v or without e connecting T^1 and T^2 . Since there does not exist an edge $\{u_1, u_2\} \in E(\tilde{G})$ with $\{u_1, u_2\} \cap V(T) = \emptyset$ we have $|M| \leq 2$ if M is a shortest path.

For $G_{|F|} = T$ condition 2 holds. Now for $i \geq 2$ let G_i be given. If there exists a vertex $u \in V(\tilde{G}) \setminus V(G_i)$ having neighbors $x, y \in V(G_i)$ with $S(G_i, x) \neq S(G_i, y)$ we define G_{i-1} by adding vertex u and adding all edges, being adjacent with u in \tilde{G} , to G_i . With this we have $|V(G_{i-1})| = |V(G_i)| + 1$ and $N(G_{i-1}) = N(G_i) - 1$, so that condition 2 is fulfilled for G_{i-1} .

Now we deal with the cases where $i \geq 2$ and where such vertices u, x, y do not exist. We use the setwise defined distance

$$d_K(A, B) := \min \left\{ d_K(a, b) : a \in A, b \in B \right\}.$$

Now we choose $f_1, f_2 \in F$ with $S(G_i, f_1) \neq S(G_i, f_2)$, where $d_{G_i}(S(G_i, f_1), S(G_i, f_2))$ is minimal. Clearly we have $1 \leq d_{G_i}(S(G_i, f_1), S(G_i, f_2)) \leq 3$. By P_{f_1, f_2} we denote the corresponding shortest path connecting $S(G_i, f_1)$ with $S(G_i, f_2)$.

If $|P_{f_1, f_2}| = [v_0, v_1]$ and the edge $\{v_0, v_1\}$ is not contained in $E(T)$, then we simply add this edge to G_i to obtain G_{i-1} . So we may assume that $\{v_0, v_1\} \in E(T)$. Deleting $\{v_0, v_1\}$ in T decomposes T into two subtrees T^1 and T^2 , where we assume w.l.o.g. that $f_1 \in V(T^1)$ and $f_2 \in V(T^2)$. Due to

$d_{\tilde{G} \setminus \{v_0, v_1\}}(T^1, T^2) \leq 2$ we can obtain a graph G_{i-1} adding add most one vertex, where $S(G_{i-1}, f_1) = S(G_{i-1}, f_2)$ holds.

If $|P_{f_1, f_2}| = [v_0, v_1, v_2]$ and $v_1 \notin V(T)$ then we can add v_1 and add all its edges to G_i to obtain G_{i-1} . So we may assume $v_1 \in V(T)$. If $\{v_0, v_1\}$ or $\{v_1, v_2\}$ would not be contained in $E(T)$, then we may simply add it to G_i , without increasing the number of vertices, and are in a case $|P_{f_1, f_2}| = 1$. So we may assume $\{v_0, v_1\}, \{v_1, v_2\} \in E(T)$. Due to $S(G_i, v_0) \neq S(G_i, v_1) \neq S(G_i, v_2)$ and the minimality of P_{f_1, f_2} we have $v_1 \notin F$. Thus v_1 has degree two in T and removing v_1 decomposes T into two subtrees T^1 and T^2 , where we assume w.l.o.g. that $f_1 \in V(T^1)$ and $f_2 \in V(T^2)$. Since there does not exist a cut vertex in \tilde{G} we have $d_{\tilde{G} \setminus \{v_1\}}(T^1, T^2) \leq 2$ and we can obtain a graph G_{i-1} adding add most one vertex, where $S(G_{i-1}, f_1) = S(G_{i-1}, f_2)$ holds.

The remaining case is $|P_{f_1, f_2}| = [v_0, v_1, v_2, v_3]$. Due to the minimality of P_{f_1, f_2} we have $f(v_2) \in V(S(G_i, f_2))$ and $f(v_1) \in V(S(G_i, f_1))$. Thus we may assume $v_0, v_3 \in \tilde{D}$. Additionally we have $\{v_1, v_2\} \cap V(T) \neq \emptyset$. If $v_3 \notin V(T)$ we may simply add v_3 and its edges to G_i to obtain G_{i-1} . So we may assume $v_1, v_2 \in V(T)$. W.l.o.g. we assume $\{v_1, v_2\} \in E(T)$. Otherwise there exists an edge $\{v_1, v_4\} \in E(T)$ with $v_4 \neq v_0$ and we could choose $f_1 = f(v_1)$, $f_2 = f(v_4)$. The vertices v_1 and v_2 both have degree two in T . Deleting v_1 in T gives two subtrees T^1 and T^2 , where we can assume $v_0 \in V(T^1)$ and $v_2 \in V(T^2)$. Since there does not exist a cut vertex in \tilde{G} we have $d_{\tilde{G} \setminus \{v_1\}}(T^1, T^2) \leq 2$ and denote the corresponding shortest path by R_1 . If $R_1 = [r_0, r_1, r_2]$ does not end in v_2 then we could obtain G_{i-1} by adding vertex r_1 and its edges to G_i . Similarly we may delete vertex v_2 to obtain a shortest path R_2 which ends in v_1 . But in this case the edge $\{v_1, v_2\}$ could be deleted from \tilde{G} , which is a contradiction to the minimality of \tilde{G} . \square

We remark that we conjecture that if G is a critical minimal subgraph of a pair (G', D) in first standard form then we always can apply one of the lemmas 3.1, 3.2, 3.3, 3.4, 3.6, 3.7, 3.8, 3.9, 3.10, 3.11, 4.2, or 4.3.

We would like to remark that our reduction technique is constructive in the following sense: If we have a graph G and a dominating set D , not necessarily a minimal dominating set of G , then we can construct an orientation H of G in polynomial time fulfilling $\text{diam}(H) \leq 4 \cdot |D|$: At first we apply the transformations of the poof of Lemma 2.3 to obtain a graph \tilde{G} , which fulfills conditions (1), (3)-(6) of Definition 2.2 and where D remains a dominating set. In the following we will demonstrate how to obtain an orientation \tilde{H} of \tilde{G} fulfilling $\text{diam}(\tilde{H}) \leq 4 \cdot |D|$. From such an orientation we can clearly reconstruct an orientation H of G . Since Lemma 2.5 does not use the minimality of the dominating set D we can restrict our consideration on a minimal subgraph \hat{G} of \tilde{G} . Since none of the lemmas in Section 3 uses the minimality of the domination set D , we can apply all these reduction steps on \hat{G} . These steps can easily be reversed afterwards. The proofs of Lemma 4.2 and Lemma 4.3 have to be altered very slightly to guarantee a suitable reduction also in the case where D is not minimal. (Here only the analysis is affected, not the construction.) We end up with a graph \hat{G} with dominating set \hat{D} (here \hat{D} arises from D by applying the necessary reduction steps). Since in the proof of Theorem 1.3 we show $|V(\hat{G})| \leq 4 \cdot |\hat{D}| - 3$ we can choose an arbitrary strong orientation and reverse all previous steps to obtain an orientation H of G with $\text{diam}(H) \leq 4 \cdot |D|$. We remark that all steps can be performed in polynomial time.

5. CONCLUSION AND OUTLOOK

In this article we have proven

$$\overrightarrow{\text{diam}}_{\min}(G) \leq 4 \cdot \gamma(G)$$

for all bridgeless connected graphs and conjecture

$$\overrightarrow{\text{diam}}_{\min}(G) \leq \left\lceil \frac{7\gamma(G) + 1}{2} \right\rceil$$

to be the true upper bound. Lemma 3.5 shows that Theorem 1.3 is not tight for $\gamma = 3$. Some of our reduction steps in Section 3 can also be used for a proof of Conjecture 1.4. Key ingredients might be the lemmas 4.2 and 4.3, which can be utilized as reductions for Conjecture 1.4 if $k + y$ is large enough. Figure 4 indicates several cases which can not be reduced so far.

Besides a proof of Conjecture 1.4 one might consider special subclasses of general graphs to obtain stronger bounds on the minimum oriented diameter. E. g. for C_3 -free graphs and C_4 -free graphs we conjecture that the minimum oriented diameter is at most $3 \cdot \gamma + c$.

REFERENCES

1. F. R. K. Chung, M. R. Garey, and R. E. Tarjan, *Strongly connected orientations of mixed multigraphs*, Networks **15** (1985), 477–484.
2. V. Chvátal and C. Thomassen, *Distances in orientations of graphs*, J. Comb. Theory, Ser. B **24** (1976), 61–75.
3. P. Dankelmann, *The diameter of directed graphs*, J. Comb. Theory, Ser. B **94** (2005), no. 1, 183–186.
4. P. Dankelmann, O. R. Oellermann, and J.-L. Wu, *Minimum average distance of strong orientations of graphs*, Discrete Appl. Math. **143** (2004), no. 1-3, 204–212.
5. P. Dankelmann, H. C. Swart, and D. P. Day, *On strong distances in oriented graphs*, Discrete Math. **266** (2003), no. 1-3, 195–201.
6. R. Diestel, *Graph theory*, second ed., Springer-Verlag, New York, 2000.
7. F. V. Fomin, M. Matamala, E. Prisner, and I. Rapaport, *Bilateral orientations and domination*, Proceedings of the Brazilian Symposium on Graphs, Algorithms and Combinatorics (GRACO 2001), Electronic Notes in Discrete Mathematics, vol. 7, Elsevier Science Publishers, 2001.
8. ———, *AT-free graphs: Linear bounds for the oriented diameter*, Discrete Appl. Math. **141** (2004), no. 1-3, 135–148.
9. F. V. Fomin, M. Matamala, and I. Rapaport, *The complexity of approximating the oriented diameter of chordal graphs. (extended abstract)*, Kučera, Luděk (ed.), Graph-theoretic concepts in computer science. 28th international workshop, WG 2002, Český Krumlov, Czech Republic, June 13-15, 2002. Revised papers. Berlin: Springer. Lect. Notes Comput. Sci. 2573, 211-222 (2002), 2002.
10. ———, *Complexity of approximating the oriented diameter of chordal graphs*, J. Graph Theory **45** (2004), no. 4, 255–269.
11. K. M. Koh and K. L. Ng, *The orientation number of two complete graphs with linkages*, Discrete Math. **295** (2005), no. 1-3, 91–106.
12. K. M. Koh and B. P. Tan, *The diameter of an orientation of a complete multipartite graph*, Discrete Math. **149** (1996), no. 1-3, 131–139.
13. ———, *The minimum diameter of orientations of complete multipartite graphs*, Graphs Comb. **12** (1996), no. 4, 333–339.
14. K. M. Koh and E. G. Tay, *Optimal orientations of products of paths and cycles*, Discrete Appl. Math. **78** (1997), no. 1-3, 163–174.
15. ———, *On optimal orientations of cartesian products with a bipartite graph*, Discrete Appl. Math. **98** (1999), no. 1-2, 103–120.
16. ———, *On optimal orientations of cartesian products of graphs. II: Complete graphs and even cycles*, Discrete Math. **211** (2000), no. 1-3, 75–102.
17. ———, *On optimal orientations of G vertex-multiplications*, Discrete Math. **219** (2000), no. 1-3, 153–171.
18. ———, *On a conjecture concerning optimal orientations of the cartesian product of a triangle and an odd cycle*, Discrete Math. **232** (2001), no. 1-3, 153–161.
19. ———, *On optimal orientations of tree vertex-multiplications*, Australas. J. Comb. **34** (2006), 69–87.
20. J.-C. König, D. W. Krumme, and E. Lazard, *Diameter-preserving orientations of the torus*, Networks **32** (1998), no. 1, 1–11.
21. P. K. Kwok, Q. Liu, and A. B. West, *Oriented diameter of graphs with diameter 3*, (submitted).
22. J. E. McCanna, *Orientations of the n -cube with minimum diameter*, Discrete Math. **68** (1988), no. 2-3, 309–310.
23. J. Plesník, *Remarks on diameters of orientations of graphs*, Acta Math. Univ. Comenian **46/47** (1985), 225–236.
24. ———, *On minimal graphs of diameter 2 with every edge in a 3-cycle*, Math. Slovaca **36** (1986), 145–149.
25. H. E. Robbins, *A theorem on graphs, with an application to a problem in traffic control*, Amer. Math. Monthly **46** (1939), 281–283.

SASCHA KURZ, FAKULTÄT FÜR MATHEMATIK, PHYSIK UND INFORMATIK, UNIVERSITÄT BAYREUTH, GERMANY
E-mail address: sascha.kurz@uni-bayreuth.de

MARTIN LÄTSCH, ZENTRUM FÜR ANGEWANDTE INFORMATIK, UNIVERSITÄT ZU KÖLN, GERMANY
E-mail address: laetsch@zpr.uni-koeln.de